



**QUEEN'S
UNIVERSITY
BELFAST**

Post-tensioning glulam timber beams with basalt FRP tendons

McConnell, E., McPolin, D., & Taylor, S. (2015). Post-tensioning glulam timber beams with basalt FRP tendons. *Proceedings of the ICE - Construction Materials*, Article 1400032. <https://doi.org/10.1680/coma.14.00032>

Published in:

Proceedings of the ICE - Construction Materials

Document Version:

Publisher's PDF, also known as Version of record

Queen's University Belfast - Research Portal:

[Link to publication record in Queen's University Belfast Research Portal](#)

Publisher rights

Copyright © 2014 ICE Publishing, all rights reserved.

Permission is granted by ICE Publishing to print one copy for personal use. Any other use of these PDF files is subject to reprint fees

General rights

Copyright for the publications made accessible via the Queen's University Belfast Research Portal is retained by the author(s) and / or other copyright owners and it is a condition of accessing these publications that users recognise and abide by the legal requirements associated with these rights.

Take down policy

The Research Portal is Queen's institutional repository that provides access to Queen's research output. Every effort has been made to ensure that content in the Research Portal does not infringe any person's rights, or applicable UK laws. If you discover content in the Research Portal that you believe breaches copyright or violates any law, please contact openaccess@qub.ac.uk.

Open Access

This research has been made openly available by Queen's academics and its Open Research team. We would love to hear how access to this research benefits you. – Share your feedback with us: <http://go.qub.ac.uk/oa-feedback>

Post-tensioning glulam timber beams with basalt FRP tendons

Emma McConnell MEng

PhD Student, Department of Civil Engineering, Queens University Belfast, Northern Ireland, UK

Daniel McPolin MSc, PhD

Lecturer, Queens University Belfast, Northern Ireland, UK

Su Taylor MEng, PhD, CEng

Professor, Queens University Belfast, Northern Ireland, UK

Improvements in the structural performance of glulam timber beams by the inclusion of reinforcing materials can increase both the service performance and ultimate capacity. This paper describes a series of four-point bending tests conducted, under service loads and to failure, on unreinforced, reinforced and post-tensioned glulam timber beams, where the reinforcing tendon used is 12 mm dia. basalt fibre-reinforced polymer. The research is designed to evaluate the benefits offered by including an active reinforcement in contrast to the passive reinforcement typically used within timber strengthening works, in addition to establishing the effect that bonding the reinforcing tendon has on the material's performance. Further experimental tests have also been developed to investigate the long-term implications of this research, with emphasis placed upon creep and loss of post-tensioning; however, this is ongoing and is not presented in this paper. The laboratory investigations establish that the flexural strength and stiffness increase for both the unbonded and bonded post-tensioned timbers compared to the unreinforced and reinforced beams. Timber that is post-tensioned with an unbonded basalt fibre-reinforced polymer tendon shows a flexural strength increase of 2.8% and an increase in stiffness of 8.7%. Post-tensioned beams with a bonded basalt fibre-reinforced polymer tendon show increases in flexural strength and stiffness of 15.4% and 11.5% respectively.

Notation

A_t	area of timber
e	distance between reinforcing tendon and neutral axis
I	second moment of area for beam
M	moment resulting from applied load
P	post-tensioning force applied
y	distance to neutral axis from soffit
z	elastic section modulus
σ	value of stress occurring

1. Introduction

To encourage the use of timber as a primary structural material, it is crucial to further improve the structural performance of glulam. At present, engineering advancements have improved the flexural strength of timber through the inclusion of reinforcing tendons of varying materials. This research aims to further increase the performance of timber by post-tensioning it, causing an increase in both strength and stiffness.

2. Literature review

Timber sourced from sustainable forests is considerably less damaging to the environment than other construction materials.

The act of forestry, renewing and managing forests, is regarded as a beneficial process because it has the potential to reduce the concentration of atmospheric carbon dioxide by sequestering carbon. Timber has an excellent strength to weight ratio, as well as being renewable with a potentially low embodied energy. Despite the many benefits offered by timber use compared with other construction materials, it remains underused in the industry: 'timber is not widely used for primary structural elements; even though a substantial volume of renewable native material is available' (Gilfillan *et al.*, 2003). The underuse of timber as a structural material may be attributed to the naturally occurring defects within its structure. Undesirable characteristics include the presence of knots and grain defects, susceptibility to the effects of moisture and other time-dependent vulnerabilities, such as the occurrence of creep, which will affect the material's structural performance.

The limitations experienced when using timber in construction have been continually addressed in the past with the development of laminated veneer lumber (LVL) and glulam to reduce the presence of natural defects. More recently, research has been completed regarding the reinforcement of timber using various metals and fibre-reinforced polymers as an attempt to enhance the timber's strength and stiffness (Martin *et al.*, 2000; Patrick, 2004; Plevris and Triantafillou, 1995; Yeboah *et al.*, 2013).

Basalt fibre-reinforced polymer (BFRP) is a corrosion-resistant, composite material particularly suited to use within timber reinforcement as it has a low elastic modulus and therefore the two materials will have high strain compatibility. Additionally it has excellent tensile strength, approximately 2.5 times stronger than steel, while also being 3.7 times lighter. A 12 mm dia. BFRP bar has sufficient tensile strength to comfortably permit a 20 kN tensile force to be applied directly, while additional loading is applied to the beam.

Some research in reinforcing timber has been previously undertaken where researchers have concluded that the addition of FRP reinforcement can be equated to the addition of a single timber lamina (Martin *et al.*, 2000; Negrao *et al.*, 2008). It is arguable that the reinforcement utilised in these investigations is not being fully exploited, as only a fraction of its structural potential is used. By initially tensioning the material, and therefore using active reinforcement, a number of advantages can be further realised as, 'prestressing effectively increases flexural strength by introducing an initial compressive stress into the timber fibres that in service are under tension' (Brady and Harte, 2008).

This research evaluated the feasibility of strengthening timber beams by the addition of a post-tensioned BFRP tendon. Throughout the investigation, a combination of unreinforced, reinforced and post-tensioned glulam timber beams, with both unbonded and bonded BFRP tendons, were tested experimentally to determine the structural advantages. Additionally, as timber structures are commonly limited by the deformation experienced under loading as opposed to strength behaviour (Porteous and Kermani, 2009) it was crucial to consider the long-term implications of post-tensioning glulam timber. A long-term creep test was set up and is currently being monitored to allow an analysis of creep and the loss of post-tensioning force.

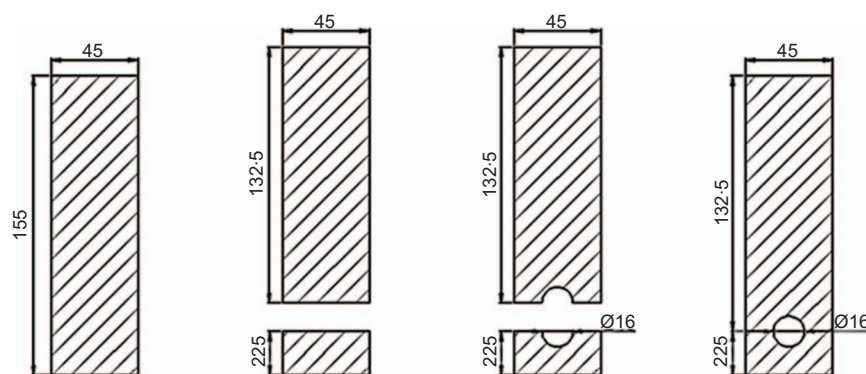

Figure 1. Diagram of initial beam preparation for R, U and B series

3. Material and methods

Twenty glulam timber beams (grade GL28, manufactured in accordance with BS EN 14080:2005 (BSI, 2005)), 3 m long, were machined to a cross section of 45 mm × 155 mm. Members that were to be reinforced were further machined to create a 16 mm dia. circular void throughout the length, its centre located 22.5 mm from the soffit, as shown in Figure 1. The void was created by removing half a lamina, 22.5 mm, from the soffit of the timber and subsequently using a router to make two semicircular grooves, dia. 16 mm, in each surface. The two sections were then bonded under pressure using a two-part epoxy resin to create the glulam beams with a 16 mm void. The beams were then divided into four groups of five members, Table 1, with the moisture content (measured using a Protimeter SM moisture meter) and a visual inspection being recorded for each

- solid GL28 control beams (C series)
- beams passively reinforced with a 12 mm dia. BFRP bar (R series)
- post-tensioned beams with an unbonded 12 mm dia. BFRP tendon (U series)
- post-tensioned beams with a bonded 12 mm dia. BFRP tendon (B series).

The materials used throughout this investigation were purchased from a number of manufacturers, as detailed below; the structural properties were further verified by material testing in the university laboratory, in accordance with BS EN 408:2010 (BSI, 2010) where appropriate.

3.1 Glulam

The European spruce was visually classified by the manufacturer as GL28c, with the structural properties shown in Table 2. Material tests were completed to obtain accurate values for the compressive and tensile strengths, with the

Series reference	No. of samples	Type	Reinforcement		Cross-section ratio: %	Post-tensioning force: kN
			Diameter: mm			
C1-C5	5	None	–	–	0.00	–
R1-R5	5	BFRP tendon	12	Bonded	1.67	0
U1-U5	5	Post-tensioned BFRP tendon	12	End anchor	1.67	20.0
B1-B5	5	Post-tensioned BFRP tendon	12	Bonded	1.67	20.0

Table 1. Series and specimen information

results and mean values shown in Tables 3 and 4. Samples of glulam timber were removed to facilitate the material tests

- 45 × 155 × 270 mm blocks were crushed parallel to the grain using an accurately calibrated hydraulic actuator to obtain the mean ultimate compressive strength
- 9 × 12 mm dog bone samples were tested in an accurately calibrated direct tension testing machine to obtain the mean ultimate tensile strength.

Tables 3 and 4 list the results from the preliminary material tests. It is evident that the material properties supplied by the glulam manufacturer are considerably lower than the results obtained in the laboratory experiments; however, until characteristic values are obtained through testing, a direct comparison is not applicable.

3.2 Basalt fibre-reinforced polymer

Basalt is the most common rock found in the earth's crust, making it an ideal choice for use within sustainable construction. With initial crystallisation problems overcome, the first basalt fibre production occurred in the USSR in the late 1980s, with the fibres being extruded from the molten rock and bonded in a matrix. The basalt fibres primarily resist the load acting upon the

Material property	Value: N/mm ²
Bending strength	28
Tensile strength parallel to the grain	16.5
Tensile strength perpendicular to the grain	0.5
Compression parallel to the grain	24
Compression perpendicular to the grain	3.0
Shear strength	2.7
Modulus of elasticity, mean value	12600
Modulus of elasticity, 5% value	10200

Table 2. GL28 Characteristic material properties from manufacturer

polymer while the resin transfers the stresses between the fibres. This combination creates a polymer that has a high tensile strength, while remaining lightweight and chemically inert.

BFRP has 2.5 times the tensile strength of steel, while being 3.7 times lighter. In addition to this the polymer is chemically inert and corrosion resistant, making it highly suited to use within this research. The basalt has a very low elastic modulus, as detailed in Table 5, indicating that there should be high strain compatibility between the reinforcing tendon and the glulam timber. Furthermore, the BFRP has a sand-coated finish meaning that there is sufficient bond strength developed between the materials, reducing the possibility of post-tensioning losses.

3.3 Adhesive

The adhesive used in all aspects of the experimental research was a two-part thixotropic epoxy adhesive specifically manufactured as a slow-setting, gap-filling epoxy adhesive and therefore ideally suited for use within this investigation (Rotafix structural adhesive (Rotafix, 2014)). The slow-setting nature of the epoxy adhesive allowed both sufficient manipulation during the construction of the glulam timbers with the 16 mm duct and time for the adhesive to flow, filling the void, during the bonding of the reinforcement and post-tensioned tendons. The manufacturers provide the material properties shown in Table 6; through basic, preliminary investigations and previous studies

Sample no.	Failure load: kN	Compressive strength: N/mm ²
1	264.9	37.4
2	281.8	39.8
3	247.6	34.9
4	273.4	38.6
5	260.3	36.7
Average	265.6	37.5

Table 3. Material testing – compressive results

Sample no.	Failure load: kN	Tensile strength: N/mm ²
1	3.65	33.8
2	3.68	34.1
3	3.33	30.8
4	5.02	46.5
5	5.07	43.3
Average	4.15	38.4

Table 4. Material testing – tensile results

conducted within the university (Tharmarajah *et al.*, 2010) it was determined that the adhesive would be sufficient for all aspects of this research.

Figure 2 illustrates results of the preliminary testing that was conducted to ensure a sufficient bond between the tendon and the timber would be achieved. Epoxy adhesive was injected through pre-drilled holes in the soffit of members that were passively and actively reinforced following elastic testing. It can be clearly seen that the preliminary testing offered positive results, with a uniform 2 mm bond line being achieved around the tendon.

3.4 Flexural test procedure

The glulam timber beams were tested using the four-point bending method in accordance to BS EN 408:2010 (BSI, 2010), with the experimental arrangement as shown in Figure 3. Beams were supported on roller supports, as was the spreader bar below the loading point. Lateral supports were provided to resist any lateral torsional effects that may have occurred.

Owing to the variability of timber it was necessary to test each beam elastically to allow an accurate comparison of the various states of reinforcing to occur. To assess the benefits provided by both simple reinforcing and post-tensioning, each timber beam was tested elastically as follows

- control, solid timber beam
- 12 mm BFRP tendon slotted slack through the timber beam

and either

Tensile strength: MPa	Elastic modulus: GPa	Ultimate strain: $\mu\epsilon$
618	54	11 570

Table 5. Material properties – BFRP

Material property	Value: N/mm ²
Compressive strength	> 60
Tensile strength	40
Tensile modulus	3000
Flexural strength	70
Bond strength	6
(Workable for 6 hours at 20°C)	

Table 6. Epoxy adhesive properties from manufacturer

- 12 mm BFRP tendon bonded as passive reinforcement (R series)

or

- 12 mm BFRP tendon, post-tensioned to 20 kN, unbonded (U and B series)
- 12 mm BFR tendon, post-tensioned to 20 kN, bonded (B series).

The elastic tests were conducted by applying an initial load of 10 kN, increasing in increments of 1 kN, with data recorded at each interval on all instrumentation. The 10 kN load was held for 5 min, unloaded incrementally and all load removed for a further 5 min prior to the second elastic loading test, which proceeded in the same manner. A 10 kN load was adopted as the maximum service load as previous tests had determined that this was the largest load that could be applied and removed without adversely affecting the timber, but that would yield the largest group of data. The tests to failure were carried out using the same process following the previous elastic tests and subsequently loaded until failure occurred. The response was monitored through instrumentation and additionally documented using digital imagery.

The post-tensioned beams were initially tested as above, before application of the tension force. Once complete the tendon was tensioned using a 13 t hollow plunger cylindrical ram, located at one end of the beam. The ram was secured using open grip barrel and wedge clamps, with a load cell and bearing plates located against the timber. The tensile force was applied in increments, with deflection, strain and force data gathered at each interval. Once the tensile force was recorded at 20 kN, elastic loading followed by loading to failure occurred as detailed previously.

4. Theoretical investigation

The theoretical approach used throughout this research was two-fold, initially considering the plastic failure of a reinforced glulam timber beam and additionally considering the load required to neutralise the induced stresses resulting from the



Figure 2. Results of adhesive testing to ensure sufficient bond is achieved

post-tensioning process. Figure 4 illustrates the stress profiles for both an unreinforced and reinforced timber beam at failure. Throughout this research profiles Figure 4(a) and Figure 4(d) were used to calculate the ultimate capacity of the various glulam timber beams.

The post-tensioned glulam timber was considered as a reinforced beam, but with additional stresses that the process induces, as illustrated by Figure 5. Equations 1 and 2 demonstrate the

theoretical approach taken, with the applied moment calculated as that required to create a zero stress scenario.

For σ_{top}

$$1. \quad -\frac{My}{I} = \frac{P}{A_t} - \frac{Pe}{z}$$

For σ_{bottom}

$$2. \quad \frac{My}{I} = \frac{P}{A_t} + \frac{Pe}{z}$$

where P (kN) is the post-tensioning force; A_t (mm^2) is the area of timber; e (mm) is the eccentricity of tendon placement; z (mm^3) is the section modulus; M (kN m) is the applied moment; y (mm) is the distance to neutral axis; and I (mm^4) is the second moment of area.

Table 7 shows the average experimental results and the theoretical values obtained. The average material properties found through preliminary testing were used, explaining the large percentage error. The authors believe the approach to be accurate and that further material tests to obtain a more representative value for both the compressive and tensile strengths will increase the accuracy.

5. Experimental results and discussion

5.1 Unreinforced control beams

Figure 6 illustrates the typical deflection response of an unreinforced beam tested throughout the research. As shown, the typically proportional trend line continues until the failure of the beam, indicating that the failure mode was sudden and brittle, as witnessed throughout the testing.

The C series of tests provides a benchmark for comparison with the other series experimentally tested and, as such, a point to measure any benefits provided by the additional reinforcement and post-tensioning.

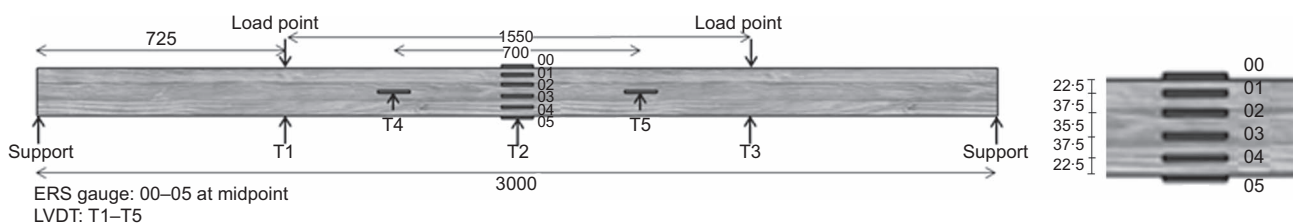

Figure 3. Test instrumentation and arrangement

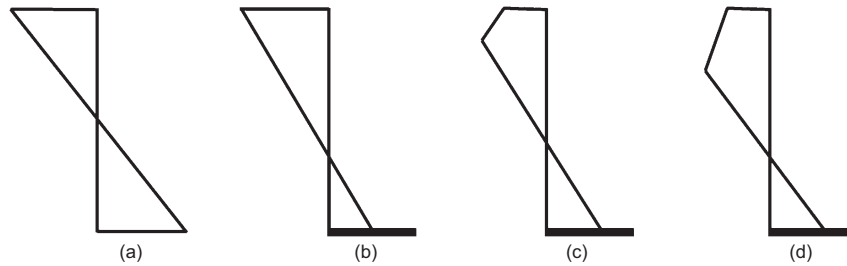

Figure 4. Stress profiles of unreinforced and tension-reinforced glulam timber: (a) ultimate unreinforced; (b) elastic reinforced; (c) plastic reinforced; (d) ultimate reinforced

5.2 Passively reinforced beams

Timbers with a bonded 12 mm dia. BFRP reinforcing tendon were tested, as detailed previously, to provide a comparison between active and passive reinforcement.

Figure 7 indicates the average experimental ultimate capacity of all series tested within the research. Contrary to previous research conducted within the university, as well as other industry-based research (Gilfillan *et al.*, 2003; Li *et al.*, 2014; Zhang *et al.*, 2011) the addition of the FRP tendon did not increase the timber’s strength. It is the authors’ belief that the variability of timber has influenced the series of tests and samples have been removed from each specimen to facilitate material tests in an attempt to explain this anomaly.

5.3 Post-tensioned beams, unbonded

Figure 8 illustrates the advantage that the post-tensioning of glulam timber offers, primarily an increase in the material’s stiffness. Considering the figure, the load–deflection response for a single beam under elastic loading conditions during several different states of construction is shown. Slotting the BFRP tendon through the void and testing elastically was carried out to highlight that the simple addition of the tendon did not affect the response of the beam, as shown in the figure.

Considering the post-tensioned, unbonded tendon it is evident that there is a reduction in the central deflection when the

elastic loading is applied. On average the reduction corresponds to an increase in stiffness of 8.7% when the response is compared to the solid timber. A further reduction in the service deflection of the glulam timber would be appreciated in industry as the post-tensioning process initially induces a camber into the member, which has been ignored in this case. Additionally, Figure 7 highlights the average increase of the ultimate capacity witnessed within this series of beams.

5.4 Post-tensioned beams, bonded

Post-tensioned glulam timber with a bonded BFRP tendon was included in the testing programme to provide insight into the benefits offered by the inclusion of the adhesive; furthermore, it is this state that is most likely to occur within industry.

Figures 9 and 10 illustrate the increase in stiffness witnessed throughout the testing, again considering a single beam in various states of construction to provide an accurate comparison between the states. When the precamber is ignored, as in Figure 9, there is a stiffness increase of 11.5%, which highlights both the benefits of post-tensioning and bonding the tendon. Considering the precamber, a 43.7% reduction in the service deflection of the glulam timber is evident.

Figure 11 shows the typical stress profile at the elastic load of 10 kN, determined from the strain gauges located on the timber throughout the tests by using a previously defined

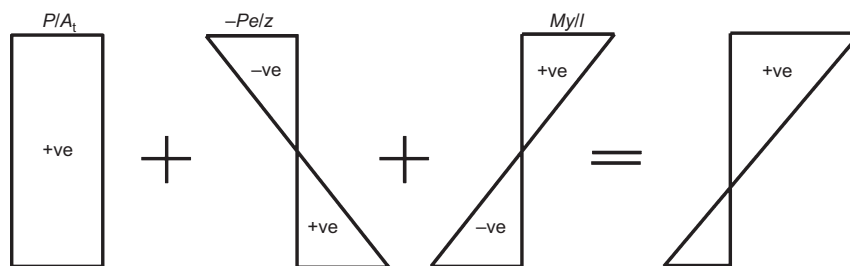

Figure 5. Illustration of post-tensioning principal stresses

	C series	R series	B series
Theoretical ultimate capacity: kN	18.5	27.0	31.9
Average experimental ultimate capacity: kN	19.9	19.3	22.9
Error: %	-7.0	39.9	39.3

Table 7. Theoretical investigation of bonded, post-tensioned glulam timber

elastic modulus, Table 5. The peak compressive stress is shown to be located below the surface of the beam, corresponding with the theoretical profiles previously defined.

5.5 Discussion

It is evident from Figure 7 that the flexural strength of the actively reinforced glulam timber has increased. In addition to the increase in strength, a reduction in variability is also evident when standard deviation is considered, indicating that the inclusion of reinforcement overcomes some natural defects present in the material to help standardise the response to loading.

The reduction in variability, as well as the decrease of service deflection, are significant advantages when considering the usability of timber within industry, indicating that further research into post-tensioning glulam timber would be of benefit.

6. Conclusion

The following conclusions may be drawn from the research regarding the reinforcement and post-tensioning of European spruce glulam timbers with a BFRP tendon.

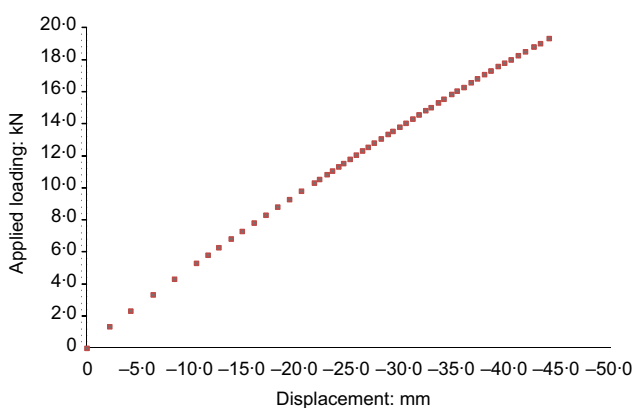

Figure 6. Typical load–deflection graph for an unreinforced glulam timber beam

- Passive reinforcement of glulam timber using a bonded, 12 mm dia., BFRP tendon increases the stiffness of the member by 15.8%.
- Active reinforcement of glulam timber using an unbonded, 12 mm dia., post-tensioned BFRP tendon increases the ultimate capacity and stiffness of the member by 2.8% and 8.7% respectively.
- Active reinforcement of glulam timber using a bonded, 12 mm dia., post-tensioned BFRP tendon increases the ultimate capacity and stiffness of the member by 15.4% and 11.5% respectively.
- The unreinforced glulam timber failed in bending with a brittle failure occurring primarily on the soffit of the beams.
- Both the passively and actively reinforced glulam timbers failed in bending with a more ductile failure mode, characterised by some visible compression, but primarily failed in tension.
- No debonding or delaminating occurred, indicating that the timber–adhesive interface had sufficient strength for use within the research.

The research discussed in this paper highlights the additional benefits that active reinforcement of glulam timber offers when compared to traditional passive reinforcement. By post-tensioning

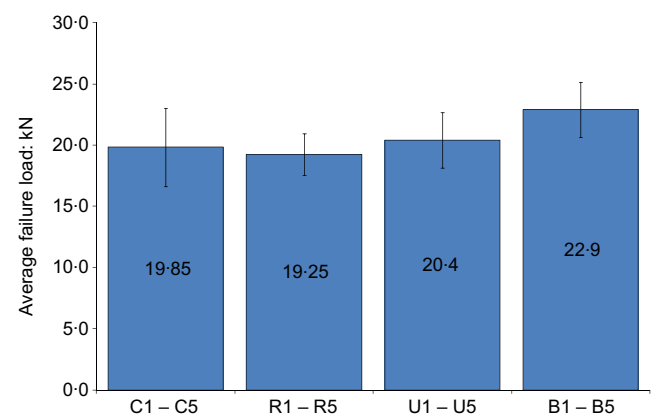

Figure 7. Average ultimate capacity with standard deviation error bars for all test series'

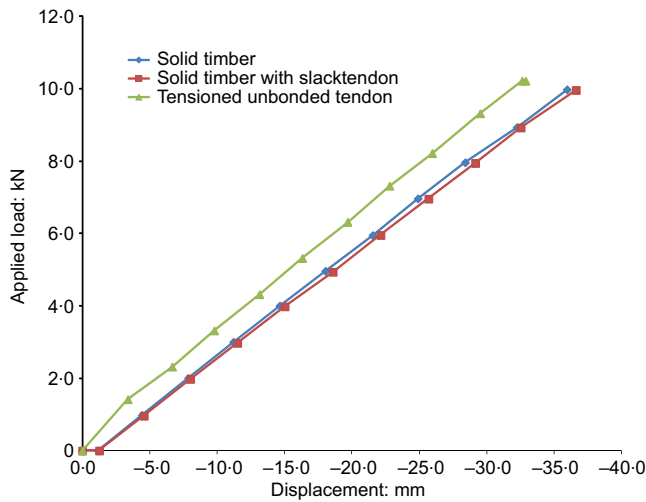

Figure 8. Typical load–deflection response of a post-tensioned, unbonded glulam timber during elastic loading with precamber ignored

the timber, increases in both ultimate capacity and stiffness are evident, with the additional benefit of an induced precamber. A more ductile failure mode was observed in reinforced timbers, which is considerably more desirable than the typical brittle failure of the unreinforced material. Although the theoretical investigation remains ongoing the research indicates that post-tensioning timber is a viable and worthwhile development in the

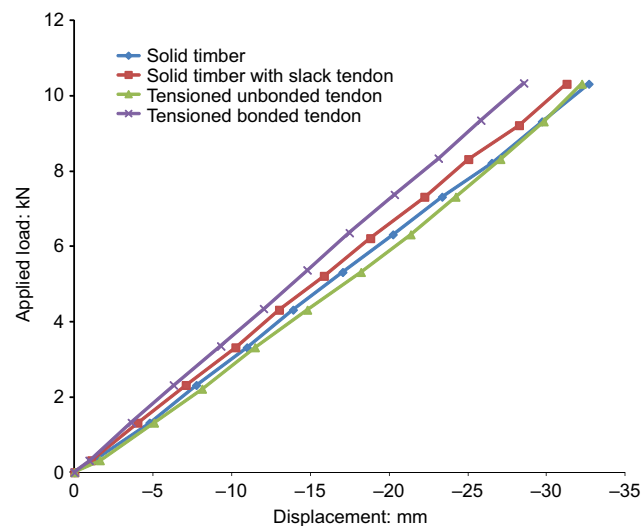

Figure 9. Typical load–deflection response of a post-tensioned, bonded glulam timber during elastic loading with precamber ignored

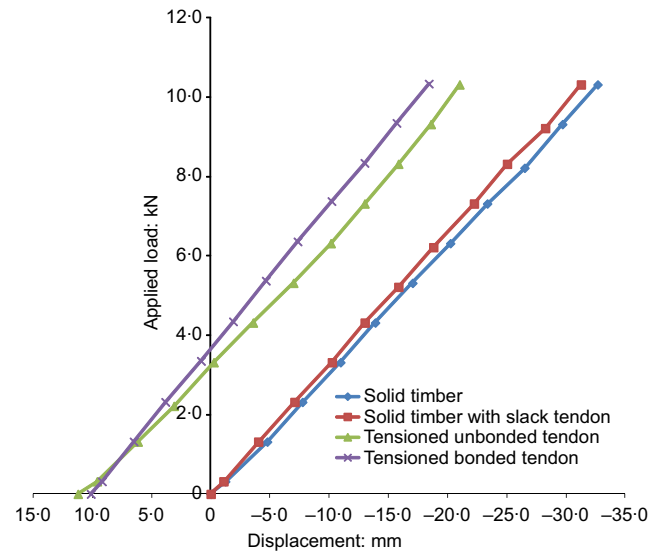

Figure 10. Typical load–deflection response of a post-tensioned, bonded glulam timber during elastic loading with precamber considered

efforts to strengthen timber and increase its usability within construction.

Although increases were evident when the glulam timber was post-tensioned, it is believed that the increases could be greater if a different material was used as the reinforcing tendon. BFRP has a relatively low elastic modulus and it is suggested

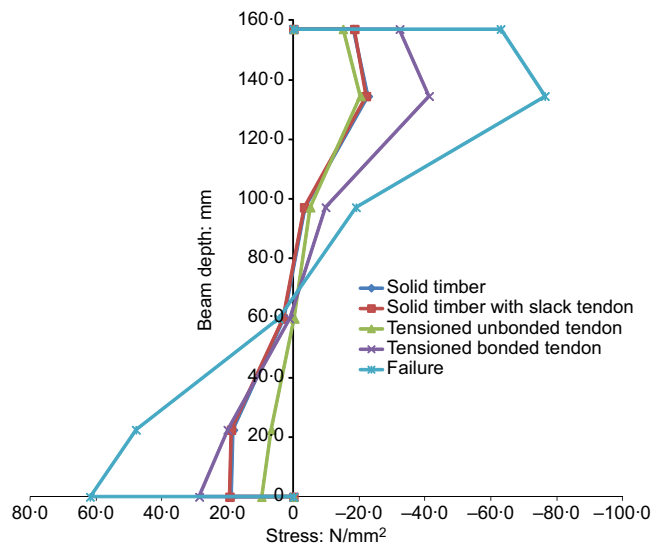

Figure 11. Typical stress profile for a post-tensioned, bonded, glulam timber during elastic loading and failure

that further research in this field should consider post-tensioning glulam timber using a material with a higher value of elastic modulus, such as aramid fibre-reinforced polymer (AFRP). By using a stiffer material it is suggested that the overall performance of the timber would be further enhanced. Additionally, as previously mentioned, long-term tests are currently underway to investigate the effects of creep and loss of post-tensioning over time.

Acknowledgement

The author (E.M.) gratefully acknowledges the continued work and support from supervisors and the laboratory technicians within the university.

REFERENCES

- Brady JF and Harte AM (2008) Prestressed FRP flexural strengthening of softwood glue-laminated timber beams. In *Proceedings of 10th World Conference on Timber Engineering (WCTE), Miyazaki, Japan*. Engineered Wood Products Association, Curran Associates, Red Hook, NY, USA, vol. 2, pp. 910–917.
- BSI (2005) BS EN 14080:2005; Timber structures. Glued laminated timber, requirements. BSI, London, UK.
- BSI (2010) BS EN 408:2010; Timber structures. Structural timber and glued laminated timber. Determination of some physical and mechanical properties. BSI, London, UK.
- Gilfillan JR, Gilbert SG and Patrick GRH (2003) The use of FRP composites in enhancing the structural behavior of timber beams. *Journal of Reinforced Plastics and Composites* **22(15)**: 1373–1388, <http://dx.doi.org/10.1177/073168403035583>.
- Li YF, Tsai MJ, Wei TF and Wang WC (2014) A study on wood beams strengthened by FRP composite materials. *Construction and Building Materials* **62**: 118–125, <http://dx.doi.org/10.1016/j.conbuildmat.2014.03.036>.
- Martin ZA, Stith JK and Tingley DA (2000) Commercialization of FRP reinforced glulam beam technology. In *Proceedings of the 6th World Conference on Timber Engineering WCTE*, Whistler Resort, British Columbia, Canada.
- Negrão J, Brunner M and Lehmann M (2008) Pre-stressing of timber. In *Bonding of Timber* (Richter K and Cruz H (eds)). Core Document of the COST Action E34, Working Group 1: Bonding on site, pp. 29–36.
- Patrick G (2004) *The Structural Performance of FRP Reinforced Glued Laminated Beams Made from Homegrown Sitka Spruce*. PhD thesis, Queen's University of Belfast, UK.
- Plevris N and Triantafyllou TC (1995) Creep behavior of FRP-reinforced wood members. *Journal of Structural Engineering* **121(2)**: 174–186, [http://dx.doi.org/10.1061/\(ASCE\)0733-9445\(1995\)121:2\(174\)](http://dx.doi.org/10.1061/(ASCE)0733-9445(1995)121:2(174)).
- Porteous J and Kermani A (2009) EC5 – Deformation and creep of timber structures. *Structural Engineer* **87(17)**: 25–29.
- Rotafix (2014) *Timber Engineering Products*. See <http://rotafix.co.uk/products/timberengineering/rsa/> (accessed 10/06/2014).
- Tharmarajah G, Taylor SE, Cleland DJ and Robinson D (2010) Basalt fibre reinforced polymer concrete slabs for sustainable bridge structures. *Proceedings of the 4th IMS International Conference on Applications of Traditional and High Performance Materials in Harsh Environments, United Arab Emirates*.
- Yeboah D, Taylor S, McPolin D and Gilfillan R (2013) Pull-out behaviour of axially loaded basalt fibre reinforced polymer (BFRP) rods bonded perpendicular to the grain of glulam elements. *Construction and Building Materials* **38**: 962–969, <http://dx.doi.org/10.1016/j.conbuildmat.2012.09.014>.
- Zhang P, Shen S and Ma C (2011) Strengthening mechanical properties of glulam with basalt fiber. *Advances in Natural Science* **4(2)**: 130–133, <http://dx.doi.org/10.3968/j.ans.1715787020110402.137>.

WHAT DO YOU THINK?

To discuss this paper, please email up to 500 words to the editor at journals@ice.org.uk. Your contribution will be forwarded to the author(s) for a reply and, if considered appropriate by the editorial panel, will be published as discussion in a future issue of the journal.

Proceedings journals rely entirely on contributions sent in by civil engineering professionals, academics and students. Papers should be 2000–5000 words long (briefing papers should be 1000–2000 words long), with adequate illustrations and references. You can submit your paper online via www.icevirtuallibrary.com/content/journals, where you will also find detailed author guidelines.