

Disinfection of Water Using Vortex Diode as Hydrodynamic Cavitation Reactor

VIKRANT GAIKWAD^{1,*} and VIVEK RANADE²

¹Department of Petrochemical and Petroleum Engineering, Maharashtra Institute of Technology, Pune-411 038, India

²Chemical Engineering and Process Development Division, CSIR-National Chemical Laboratory, Pune-411 008, India

*Corresponding author: E-mail: vikrant.gaikwad@mitpune.edu.in

Received: 25 March 2016;

Accepted: 15 April 2016;

Published online: 30 April 2016;

AJC-17907

Hydrodynamic cavitation offers distinct advantages for water disinfection and wastewater treatment particularly at large scales of operations. Vortex Diode is a fluidic device, which is conventionally used as a leaky non-return valve in nuclear industry. Recently this device was shown to be effective hydrodynamic cavitation device. In the present study, we have investigated use of cavitation in vortex diode for water disinfection application. *Escherichia coli* contaminated water is treated successfully using vortex diode. The operating parameters desirable for the disinfection are investigated. The performance is evaluated based on the reduction in the colony forming unit (CFU/mL) of *E. coli* count estimated by standard spread plate method. The presented results will be useful for identifying appropriate operating conditions for using vortex diode to effectively reduce the bacterial load and disinfect water.

Keywords: Hydrodynamic cavitation, Vortex diode, Colony forming unit, *Escherichia coli*.

INTRODUCTION

The number of human life casualties due to unsafe drinking water borne diseases in India and other developing nations is a major concern. With the increasing population the need for fresh water of which major part goes to agriculture and industrial use is going to increase and become worst by 2030. Many water treatment technologies have been in use since long. Chemical treatments are most common. However these treatment methods have severe limitations because of production of the disinfection side products. The physical methods based on UV or ultrasound has limitations on large scale operations. Out of the promising new technologies, hydrodynamic cavitation has proved to be useful on large scale operation as well [1]. When the pressure over the flowing fluid falls below its vapour pressure, the cavitation occurs. The cavitation bubbles thus formed go through growth phase and finally collapse releasing large amount of energy in a localized manner (generated very high temperature and pressure pulses). The hydrodynamic cavitation is effective due to its potential in terms of many other synergistic effects such as generation of free radicals and high turbulent shear.

The hydrodynamic cavitation is conventionally realized by introducing a constriction in the flow path where the velocity head increases at the cost of pressure head. These conventional hydrodynamic cavitation reactors use orifice and venturi *etc.* [2]. In contrast to this, vortex diode uses the

principle of conservation of tangential momentum and realized cavitation without requiring any constrictions. The vortex diode has been used for ballast water treatment using hydrodynamic cavitation for killing of zooplanktons [3]. In recent years, the vortex diode has been used for a wide range of water treatment applications [1].

In this work, we have investigated application of vortex diode for water disinfection. The vortex diode is a device, which has two ports, axial and tangential. It offers more resistance in the tangential inlet path (reverse path) than the axial inlet (forward path) therefore pressure drop is more in tangential inlet path than the axial [4]. The mode of operation with inlet *via* tangential port has a potential to realize cavitation if the flow rate is larger than a critical flow rate. At flow rates higher than critical flow rate (or the inlet pressure higher than the cavitation inception value), cavities are generated and are visible as a vortex core filled with cavities. The tail of the vortex is seen to travel downstream through the axial nozzle. The bubbles grow and collapse (implode) in downstream pipe releasing their energy in a tiny volume. The highly localized release of energy raises local pressure and temperature to very high value, which generates hydroxyl radicals. These radicals as well as very high localized shear are effective in killing microbes in water. In this work, we have investigated performance of vortex diode as a disinfection reactor. The presented results will be useful for identifying appropriate operating conditions for using vortex diode to effectively reduce the bacterial load and disinfect water.

EXPERIMENTAL

The disinfection study has been done using the *E. coli* contaminated water sample. The non-pathogenic *Escherichia coli* (ATCC No: 8739) strains are used as an indicator organism [5]. The hydrodynamic cavitation flow loop consists of a jacketed vessel with cooling water circulating through the jacket, high capacity centrifugal pump, vortex diode, bypass flow arrangement for regulation of flow through vortex diode, The pressure and flow measurement arrangements are done as per the standard installation norms. Similar arrangements have been used by previous researchers [6-8].

Experiments were performed using the operating parameters selected based on flow characteristics of the vortex diode. The initial *E. coli* concentration used for this study is 10^7 colony forming units per milliliter of the sample (CFU/mL). The procedure of preparing required volume of contaminated water sample from *E. coli* strains is standardized as per norms. The experiments were performed under control conditions for 1 h of flow operation. The samples were taken at every 10 min of interval from the tank under sterile conditions. The serial dilution technique was used to spread 0.1 mL of the diluted samples over the nutrient agar petri plates. The plates were inverted and kept in an incubator for 48 h at 35 °C, duplicate plates were prepared for each dilution. The CFU/mL count between 30 and 300 colonies per plate were considered for data for a given dilution.

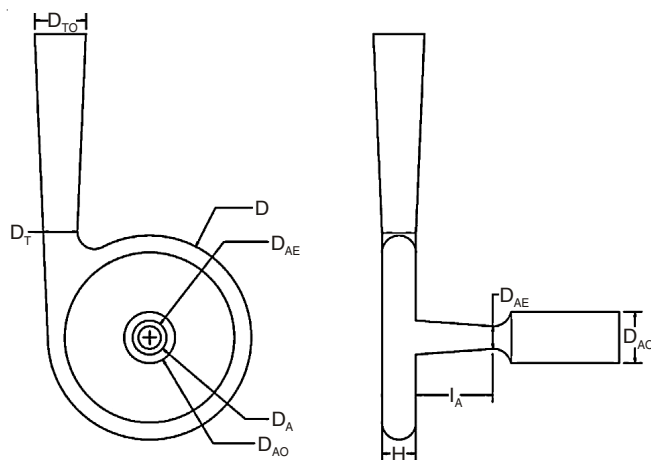

Fig. 1. Vortex Diode schematic [Ref. 9]

RESULTS AND DISCUSSION

The flow to the vortex diode for cavitation generation is through the tangential nozzle. As the flow enters the tangential nozzle its velocity increases to some distance in the chamber. The tangential velocity component goes on increasing to certain point in the diode chamber and after that as the fluid tries to leave the chamber through axial nozzle this tangential velocity component converts into axial component and the free vortex gets converted to forced vortex. The vortex in the diode chamber is a free vortex, which gets converted into a forced vortex as it approaches the axial port. Due to this, there are large pressure and velocity gradients near the axial port [9].

The increase in the velocity in the flow towards the axial nozzle reduces the pressure and thus when the conditions are such that this pressure drop falls below the vapour pressure of fluid the cavitation occurs. Fig. 2 shows the pressure drop and flow rate relationship for the vortex diode. The basic square root relationship between pressure drop and flow rate deviates at certain point and this occurs due to the inception of cavitation. Other flow characteristics within the vortex diode chamber is beyond the scope of the present work discussed here.

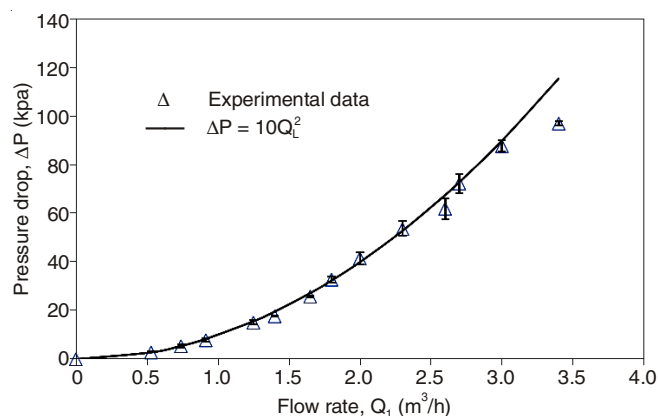

Fig. 2. Pressure drop-flow rate across vortex diode

Cavitation number: The cavitation number is defined by the following expression:

$$C_v = \frac{P_2 - P_v}{\frac{1}{2}\rho V_0^2}$$

where P_2 is the recovered pressure downstream of the axial nozzle, P_v is the vapour pressure, V_0 is the average velocity through the vortex diode, ρ is the density of the liquid. The denominator is the velocity head term, which facilitates the cavitation whereas the numerator is the pressure difference between the recovery pressure and vapour pressure of the fluid. This difference opposes the cavitation. Thus at certain point, the velocity head dominates and the cavitation inception takes place. The cavitation number $C_v > 1$ indicates that cavitation has not occurred and $C_v < 1$ indicates that the forces facilitating the cavitation are dominant, thus the cavitation number flow and pressure condition where the cavitation number falls below 1 may be taken as cavitation inception point. Due to the presence of dissolved gases in the fluid which may help cavitation to occur even at the cavitation number greater than one. Fig. 3 gives the variation of cavitation number. The cavitation regime and non-cavitation regime is clearly identified as shown in Fig. 3.

Power dissipation: The power dissipated to the fluid is the product of the flow rate and the pressure drop across the device. It is observed that as the inlet pressure increases, the velocity of the fluid through the vortex diode increases thus decreasing the pressure. The ratio of power dissipated to the fluid to the power input to the fluid is as shown in Fig. 4. The operating conditions are selected are closer to the inception point and also into the developed cavitation regime.

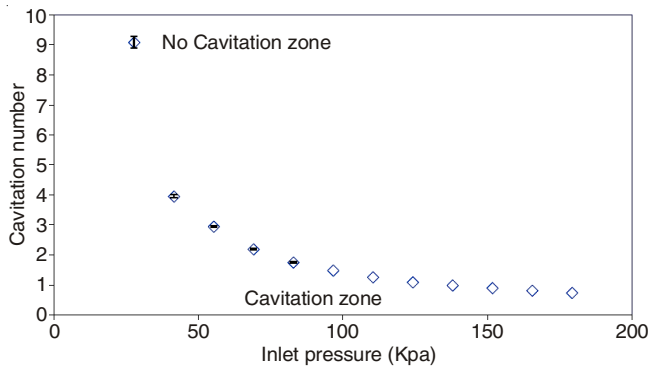

Fig. 3. Cavitation number variation with respect to inlet pressure

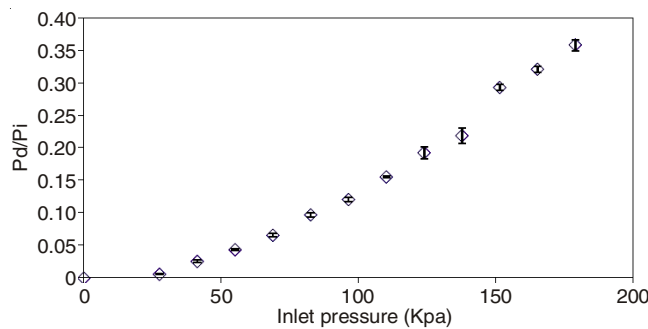

Fig. 4. Variation of the power dissipated to the fluid with increase in inlet pressure

E. coli growth curve: The bacterial growth refers to the change in the entire population of organism over a period of time rather than a change in an individual bacterial cell. To follow the course of growth, it is necessary to make quantitative measurement of growth of organisms. One of the direct ways of measuring it is the determination of increase in the optical density of the culture using a spectrophotometer or colorimeter. Bacterial cells suspended in liquid growth medium have a tendency to absorb light. Bacterial cell mass increases because of growth and there is increase in optical density so the increase in absorbance is a measure of increase in the cell mass. The characteristic phases of the growth cycle are lag phase, exponential phase, stationary phase and the death phase. Bacterial growth rates during the phase of exponential growth, under standard nutritional conditions of culture medium, temperature, pH, etc. define the bacterium's generation time. The generation time for *E. coli* is 15-20 min [5]. The generation estimated from Fig. 5 is 18.5 min. Therefore, after every 18.5 min the *E. coli* grows in the tank. The net decrease in the concentration of *E. coli* is due to the difference in the rate at which they are killed due to cavitation and due to the rate at which they regenerate.

Based on the flow characteristics, the operating conditions suitable for water disinfection are selected. To check the effect of pump operation and turbulence in pipe without cavitation, the experiments were performed keeping the bypass line fully open with no flow through the vortex diode. As shown in Fig. 6 there is no net reduction in the CFU/mL count of *E. coli*. The experiments were carried out at two different inlet pressures 100 and 140 kpa, the former is closer to cavitation inception point where as the latter is into the developed cavitation regime.

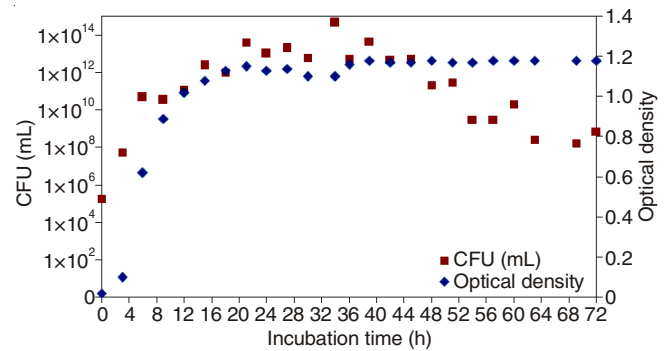

Fig. 5. *E. coli* growth curve by colony forming units and optical density method

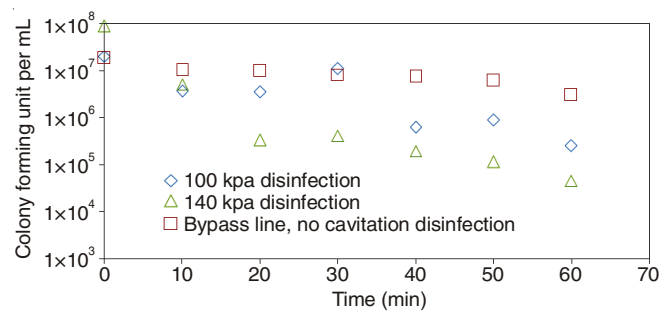

Fig. 6. Reduction in the cfu/mL of *E. coli* count due to cavitation using vortex diode

Based on the results obtained it can be clearly seen that as the cavitation is increased the extent of disinfection increases. There is a 2 log reduction in the CFU/mL count for 100 kpa inlet pressure where as for the 140 kpa inlet pressure 3 log reduction in CFU/mL is obtained. Fig. 7 shows the actual reduction in the CFU/mL count on the petri plates at different inlet pressures. It can be clearly seen that after 20 min of the experiment run there is increase in the CFU/mL count. This is due to the generation time of *E. coli* is 18.5 min, so the device has to generate sustained flow characteristics in cavitating regime in order to overcome this growth and give the net reduction in the CFU/mL count. Thus making it an effective disinfection operation.

Conclusion

Hydrodynamic cavitation compared to the conventional methods offers advantage of synergistic effect of generation of free radicals, high turbulent shear stresses, localized very high temperature and pressure pulses. Vortex diode offers advantages over conventional cavitating devices like orifice and venture since it does not use constrictions in the flow path. When operated under cavitating conditions it has found to be useful in varied industrial water treatment applications. In present work the water disinfection using vortex diode as a cavitating device has been successfully demonstrated. The approach adapted in the present work is to design the water disinfection operation based on estimation of cavitation inception point, identification of developed cavitation regime and the growth rate of *E. coli* bacteria. As the inlet pressure is increased the cavitation regime changes from non-cavitating regime to inception point to the developed cavitation regime. The extent of disinfection was found to increase with increase in flow rate or inlet pressure (no net reduction at bypass flow,

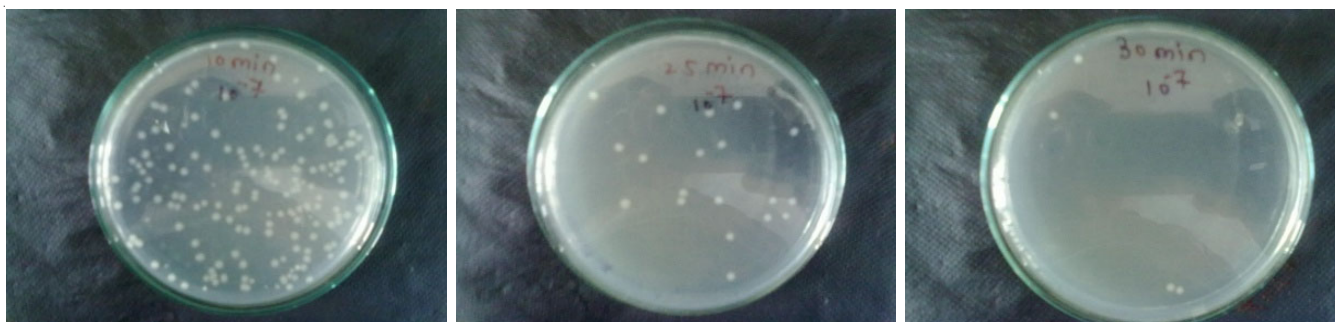

Fig. 7. Actual photograph of *E. coli* colonies at 10^7 dilution at 10, 25 and 30 min respectively. The CFU/mL count below 30 are rejected and earlier dilution result will be noted

2 log reduction at 100 kpa inlet pressure and 3 log reduction at 140 kpa inlet pressure, in 1 h of operation). The results presented here will form a basis for systematic comparison of different fluidic devices and their possible combination for effective water disinfection.

ACKNOWLEDGEMENTS

The authors are thankful to the laboratory technical supporting staff of National Chemical Laboratory, Pune, India. One of the authors (VVR) is also grateful for funding received from CSIR for the Indus MAGIC [CSC0123] program.

REFERENCES

1. V.V. Ranade and V.M. Bhandari, *Industrial Wastewater Treatment, Recycle & Reuse*, Elsevier, Amsterdam (2014).
2. P.R. Gogate, *J. Environ. Manage.*, **85**, 801 (2007).
3. S.S. Sawant, A.C. Anil, V. Krishnamurthy, C. Gaonkar, J. Kolwalkar, L. Khandeparker, D. Desai, A.V. Mahulkar, V.V. Ranade and A.B. Pandit, *Biochem. Eng. J.*, **42**, 320 (2007).
4. A.A. Kulkarni, V.V. Ranade, R. Rajeev and S.B. Koganti, *AIChE J.*, **54**, 1139 (2008).
5. M.J. Pelczar, E.C.S. Chan and N.R. Kreig, *Microbiology*, McGraw-Hill Book Co, Singapore, edn 5 (1986).
6. Arrojo, S., Benito, Y., and MartínezTarifa, A., *UltrasonicsSonochem.* **15**, 903 (2008).
7. K.K. Jyoti and A.B. Pandit, *Biochem. Eng. J.*, **7**, 201 (2001).
8. S.S. Save, A.B. Pandit and J.B. Joshi, *Trans. Inst. Chem. Eng.*, **75**, 41 (1997).
9. A. Pandare and V.V. Ranade, *Chem. Eng. Res. Des.*, **102**, 274 (2015).